

RNVB-27.20

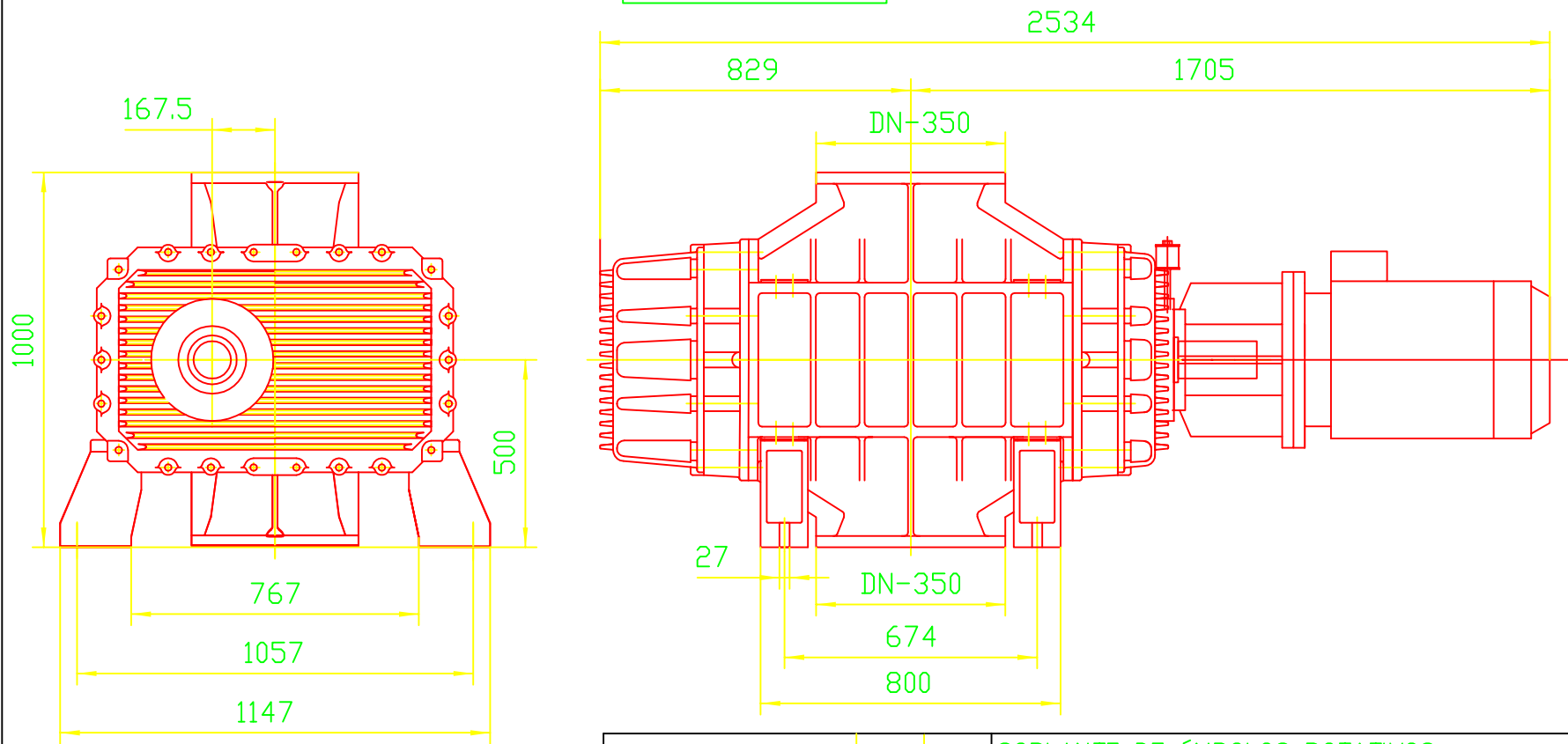

BRIDAS DIN-2532

			SOPLANTE DE ÉMBOLOS ROTATIVOS		
			CONJUNTO: RNVB-27.20 EJECUCIÓN B4 MOTOR 30kW		
			DIMENSIONES GENERALES		
			MATERIAL	CANTIDAD	PESO
Modificaciones	Fecha	Nomb.			
	FECHA	NOMBRE	ESCALA :	N°	
	Dibujado: 03.09.04	A.Elies	1:15	DIMENSIONES-27.20	
	Revisado :			Substituye a :	