

RNVB-26.30

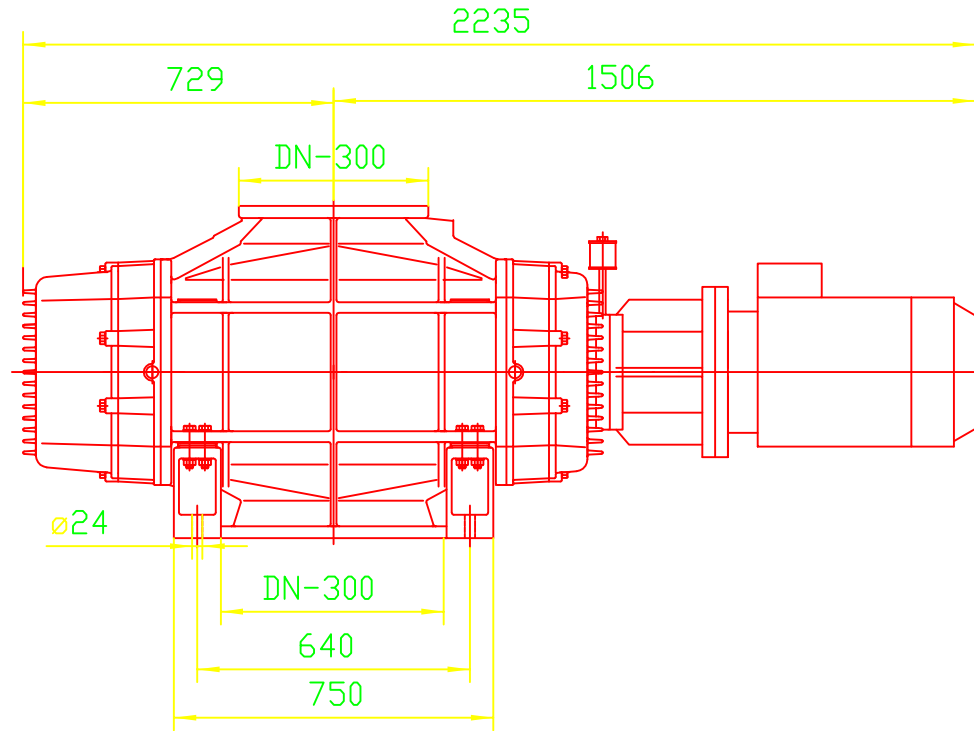
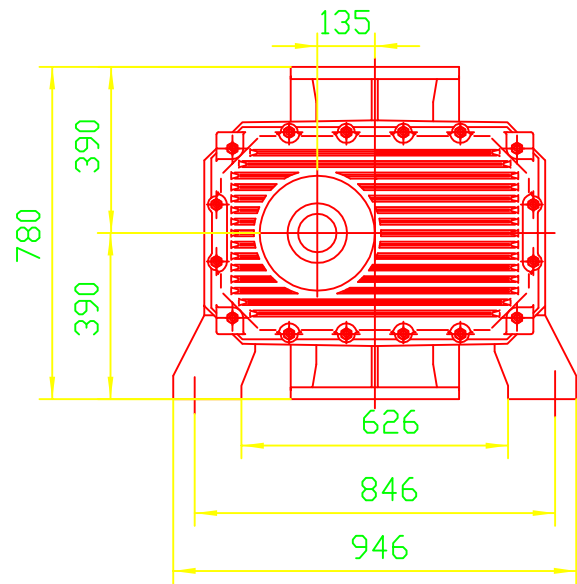

BRIDAS DIN-2532

			SOPLANTE DE ÉMBOLOS ROTATIVOS		
			CONJUNTO: RNVB-26.30 EJECUCIÓN B4 MOTOR 22kW		
			DIMENSIONES GENERALES		
			MATERIAL	CANTIDAD	PESO
Modificaciones	Fecha	Nomb.			
	FECHA	NOMBRE	ESCALA :	N°	
	Dibujado: 03.09.04	A.Elies	1:15	DIMENSIONES-26.30	
Revisado :				Substituye a :	